

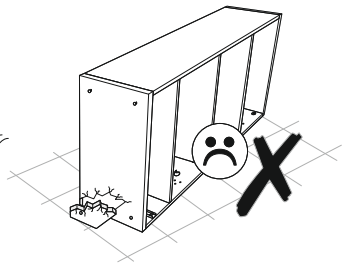

ICONIC 0002-89-140-B

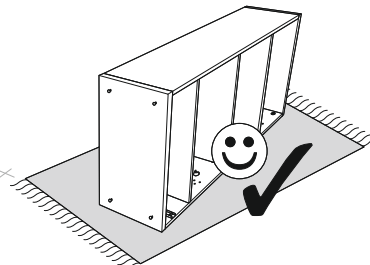

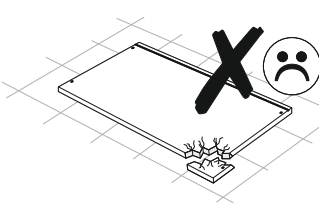
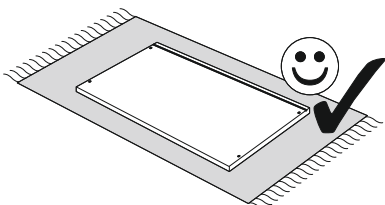
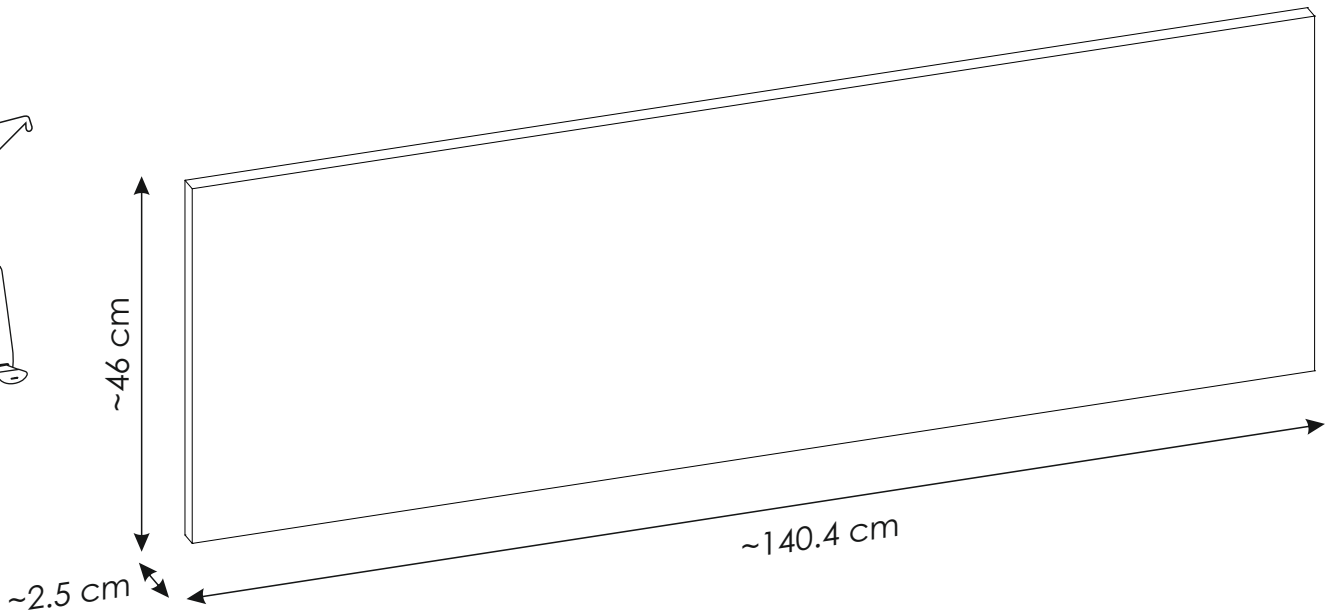
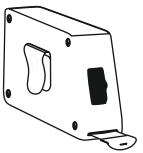
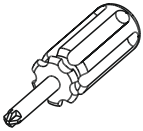
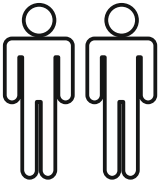
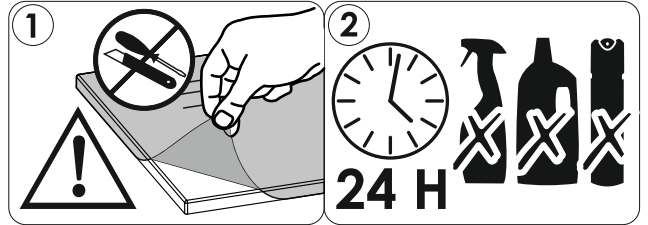

ICONIC 0002-89-140-B

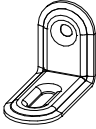
N5	3,5 x 16 mm	x36	Q8	x18
				

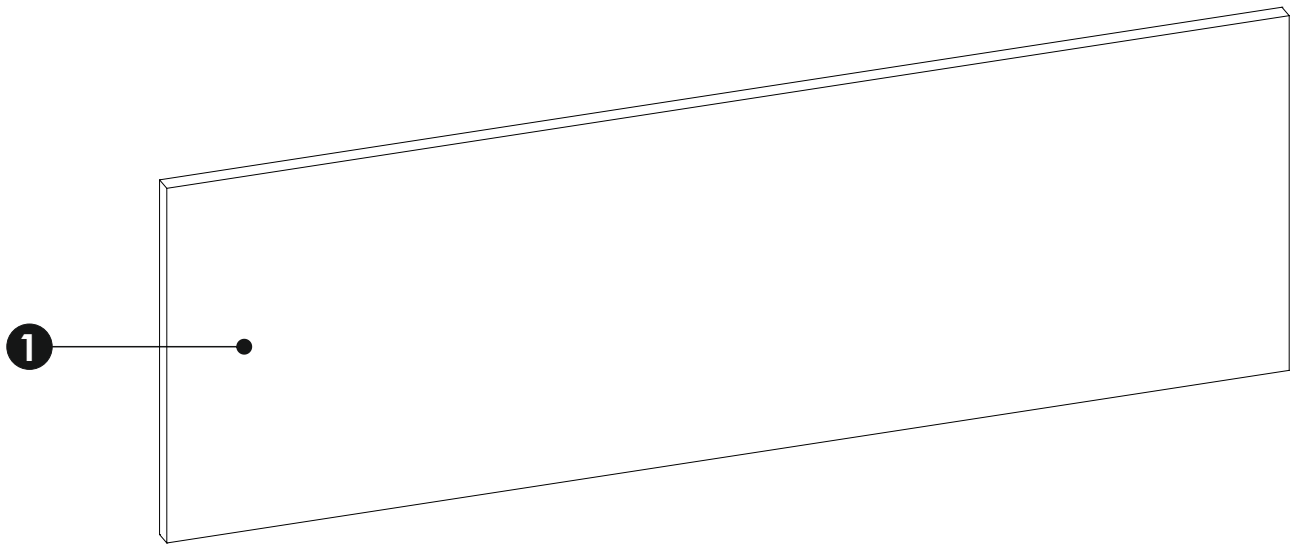

1	1404	460	25	x1	1/1
----------	------	-----	----	----	-----

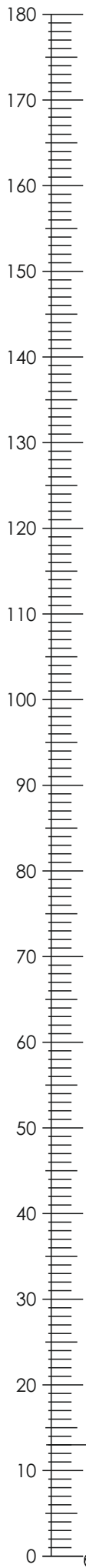

1 ▶

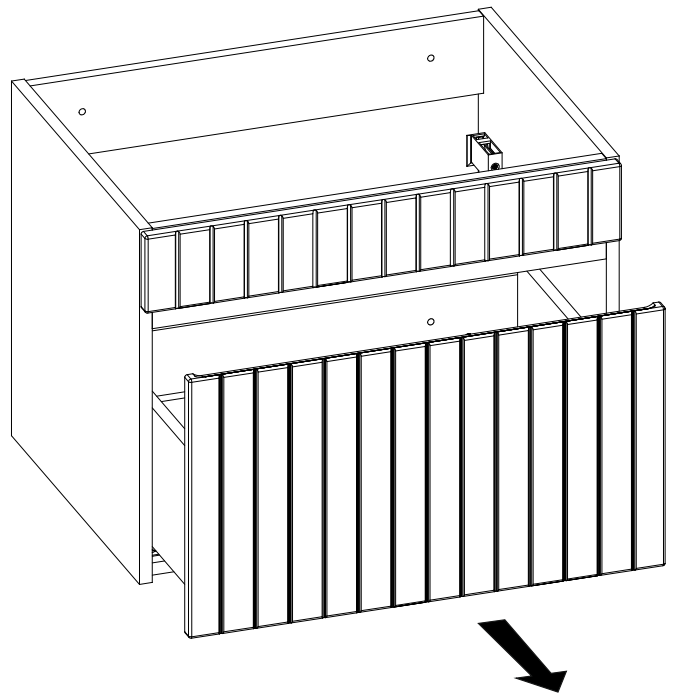
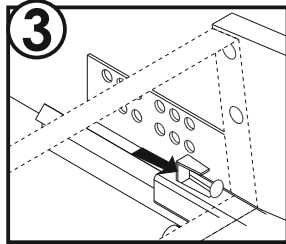
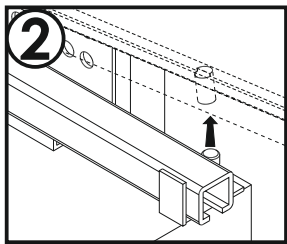
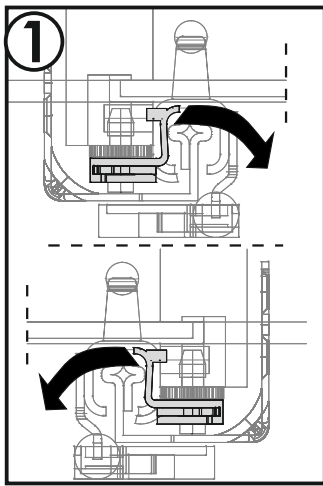

2 ▶

